

E-Z Pack[®] HCSL-1410

High Compaction Side Loader for municipal and contractor use



Like having a stationary compactor on wheels. The E-Z Pack[®] high compaction side loader: rugged, dependable, hard working. And because you get more in, you save on travel costs, fuel costs, labor costs, time costs, dump costs. Great for an economy run! Look for these fine features, too.

- low profile ram for more compaction force, remarkable payloads.
- two body closures on each side for crew convenience, efficiency.
- unique full length ram ejection for complete clean-out every time, easy-to-clean-out sump, too.
- low maintenance for optimum use, little downtime.
- has an overall capacity of 14 cubic yards and densely compacted area of 10 cubic yards —does the work of larger, costlier units.
- optional Side Dumper—one side; either or both sides.

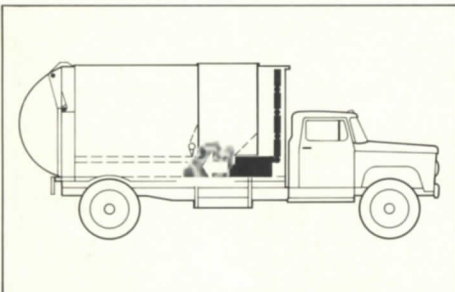

1. After refuse is dumped into side closures . . .

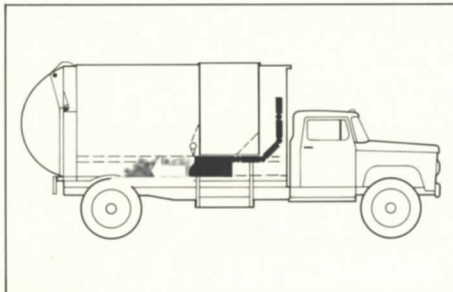

2. low profile ram begins cycle . . .

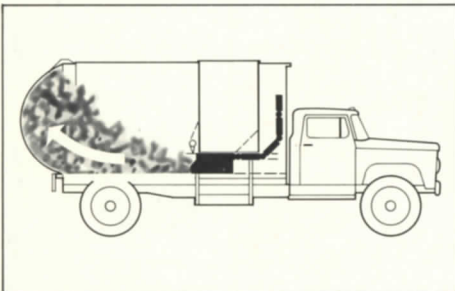

3. and pushes refuse back and up . . .

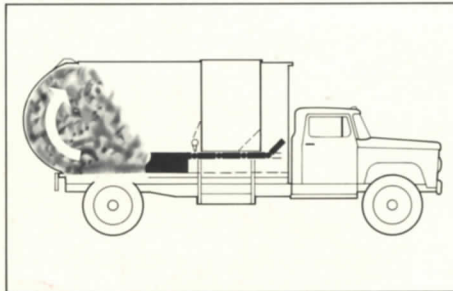

4. in circular motion for greater compaction . . .

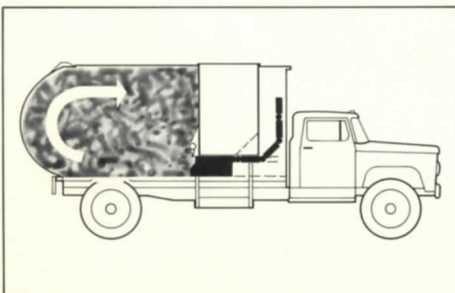

5. and greater capacity. When unit is full . . .

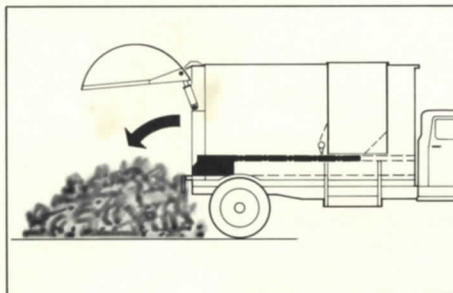

6. full-length ram ejection cleans completely.

Put our strength behind you.

Peabody Solid Wastes
Management
Galion, Ohio 44833

Patent Pending

E-Z Pack[®] HCSL-1410

High Compaction Side Loader for municipal and contractor use

Operational Features

Ram Packing Cycle	Manual/Automatic to clear loading area
Ejection Cycle	Manual Operation
Cycle Time	30 seconds
Packer/Ejection Ram	Ram is 13" high and full width of body
Packer/Ejector Cylinders	Double Acting Telescopic
Dual Operation Controls	Three control levers:
	1. Packing Cycle
	2. Full Stroke/Ejection
	3. Tailgate Lift (streetside)
Optional Side Dumper	One Side; Either or Both Sides

General Specifications

Body Length	151"
Body Width (inside)	77"
Body Width (overall)	92"
Body Height (inside)	73"
Loading Area Capacity	4 yd.
Overall Capacity	14 cubic yards
Body Closures	2 doors each side
Approximate Body Weight	6,800 lbs.
Cab-to-Axle	Min. 84"/90" recommended

Special Note: Chassis equipped with diesel engine requires full variable speed governor.

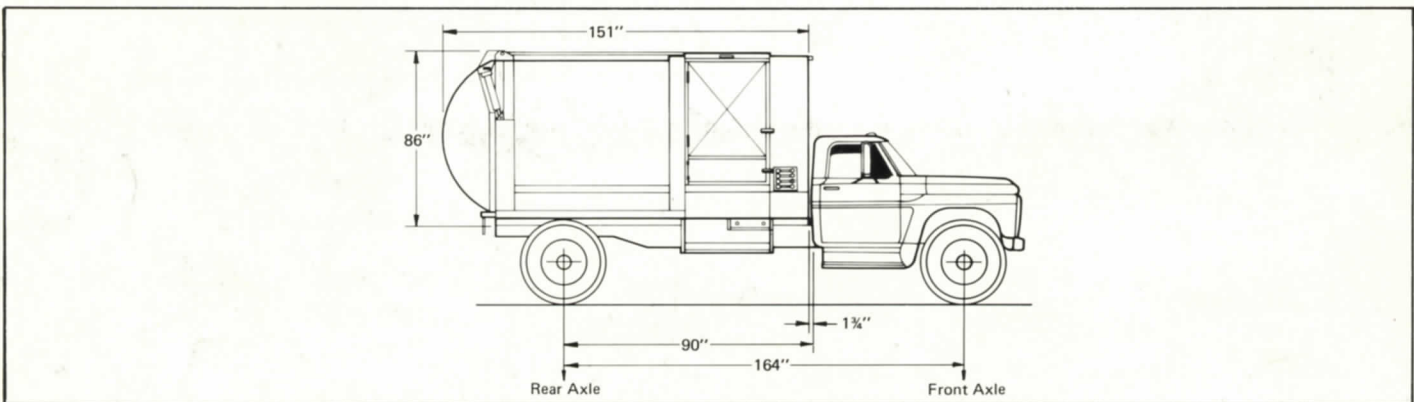

Put our strength behind you.

DISTRIBUTED BY



The Proven Authority on Solid Wastes Handling Equipment and Systems
Makers of Equipment and Systems with the E-Z Pack Trademark

ClassicRefuseTrucks.com Library

ALL SPECIFICATIONS SUBJECT TO CHANGE WITHOUT NOTICE

For information on our factory authorized leasing programs telephone 800/547-4905 toll free.

© 1974 Peabody Galion Corporation

Form No. EZ-416PSWM

Printed in U.S.A.